

## U1DF THRU U1MF

### 1.0AMP. SURFACE MOUNT ULTRA FAST RECTIFIER

#### FEATURE

- . Low leakage
- . Low forward voltage drop
- . High current capability
- . High surge capability
- . High reliability
- . High temperature soldering guaranteed:  
260°C/10 seconds at terminals.
- . For surface mounted application.
- . Easy pick and place.

#### MECHANICAL DATA

- . Terminal: Plated axial leads solderable per MIL-STD 202E, method 208C
- . Case: Molded with UL-94 Class V-0 recognized Flame Retardant Epoxy
- . Polarity: color band denotes cathode
- . Mounting position: any

#### SMF

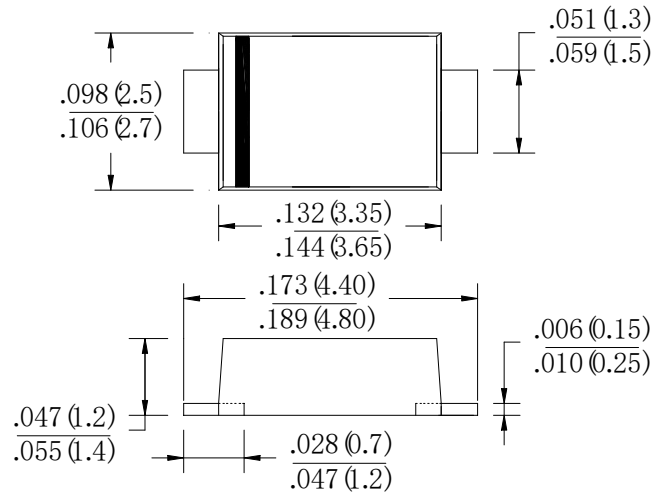

Dimensions in inches and (millimeters)

### MAXIMUM RATINGS AND ELECTRICAL CHARACTERISTICS

Ratings at 25°C ambient temperature unless otherwise specified.

Single phase, half wave, 60Hz, resistive or inductive load. For capacitive load, derate current by 20%

Type Number	SYM BOL	U1DF	U1GF	U1MF	units
Maximum Recurrent Peak Reverse Voltage	$V_{RRM}$	200	400	1000	V
Maximum RMS Voltage	$V_{RMS}$	140	280	700	V
Maximum DC blocking Voltage	$V_{DC}$	200	400	1000	V
Maximum Average Forward Rectified Current	$I_{F(AV)}$	1.0			A
Peak Forward Surge Current 8.3ms single half sine-wave superimposed on rated load (JEDEC method)	$I_{FSM}$	30.0			A
Maximum forward Voltage at 1.0A DC	$V_F$	1.0	1.3	1.7	V
Maximum DC Reverse Current @ $T_A=25^\circ C$ at rated DC blocking voltage @ $T_A=125^\circ C$	$I_R$	5.0 100.0			$\mu A$
Maximum Reverse Recovery Time (Note 1)	$t_{rr}$	50		75	nS
Typical Junction Capacitance (Note 2)	$C_J$	20		15	pF
Typical Thermal Resistance (Note 3)	$R_{(JA)}$	88			$^\circ C/W$
	$R_{(JC)}$	28			
Storage Temperature	$T_{STG}$	-55 to +150			$^\circ C$
Operation Junction Temperature	$T_J$	-55 to +150			$^\circ C$

#### Note:

1. Test Conditions:  $I_F=0.5A$ ,  $I_R=1.0A$ ,  $I_{RR}=0.25A$
2. Measured at 1.0 MHz and applied reverse voltage of 4.0Vdc
3. Measured on P.C.Board with  $0.2 \times 0.2'' (5.0 \times 5.0mm)$  Copper Pad Areas.

**RATING AND CHARACTERISTIC CURVES**

FIG.1-TYPICAL FORWARD CURRENT DERATING CURVE

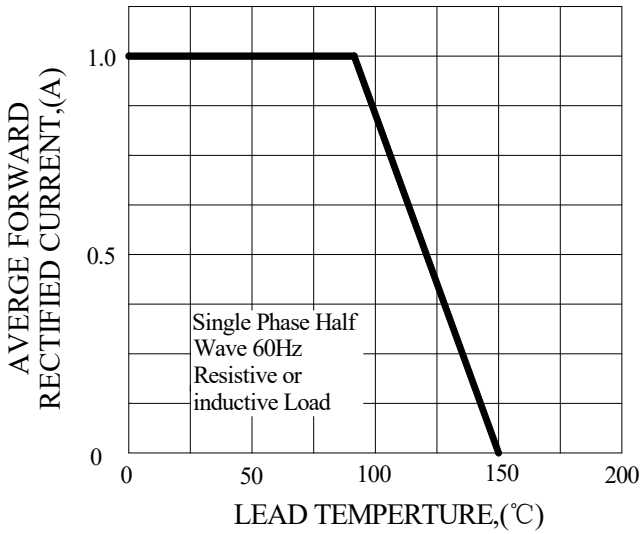

FIG.2-TYPICAL INSTANTANEOUS FORWARD CHARACTERISTICS

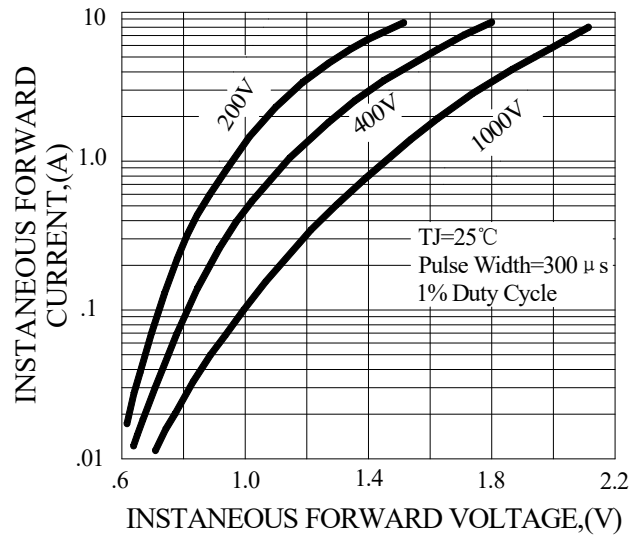

FIG.3-MAXIMUM NON-REPETITIVE FORWARD SURGE CURRENT

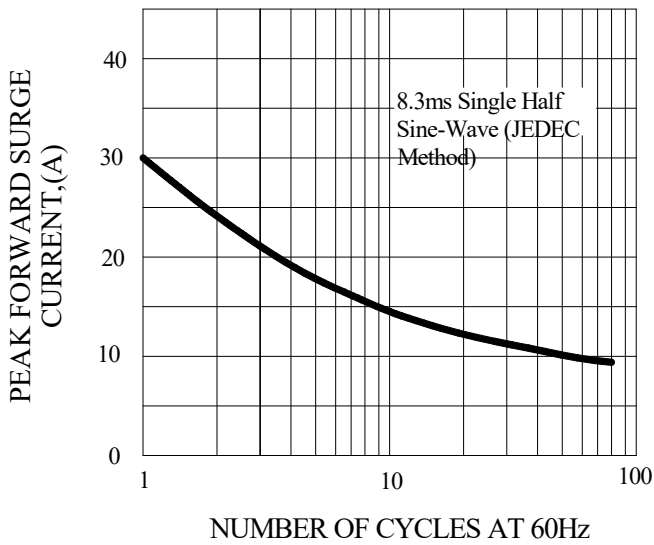

FIG.4-TYPICAL REVERSE CHARACTERISTICS

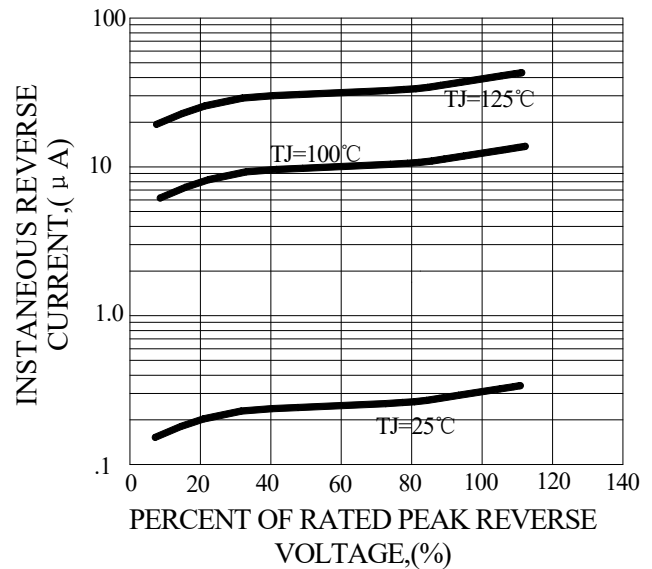
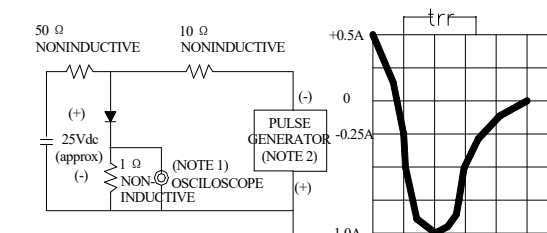

FIG.5-TEST CIRCUIT DIAGRAM AND REVERSE RECOVERY TIME CHARACTERISTIC



NOTES: 1. Rise Time=7ns max, Input Impedance= 1 megohm.22pF.  
2. Rise Time=10ns max, Source Impedance= 50 ohms.

## Marking and packaging illustration

### 1、Marking

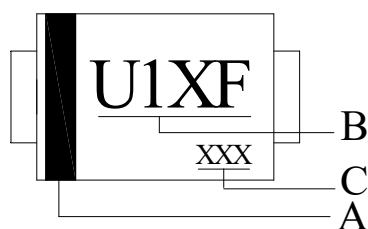

SYMBOL	Explanation
A	Color Band Denotes Cathode
B	Product Name
C	Date Code

### 2、Packaging

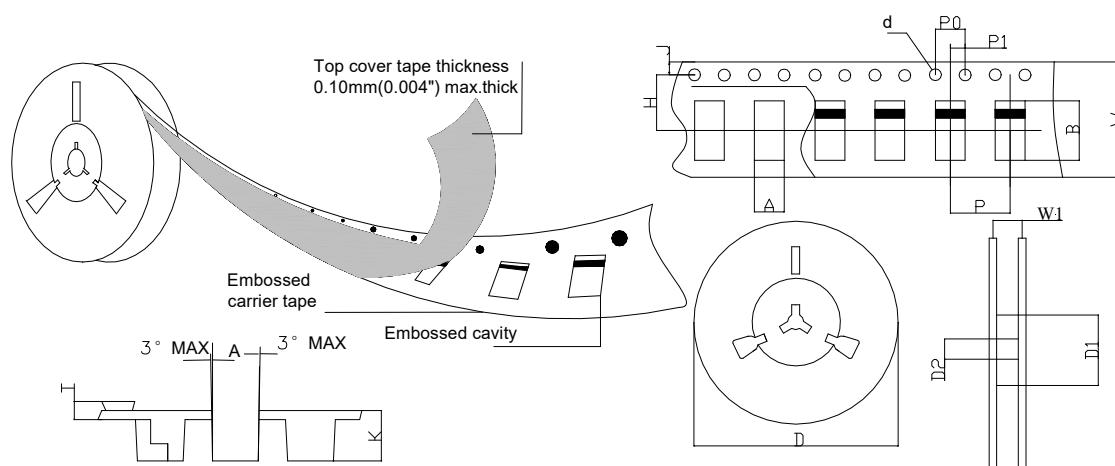

SPECIFICATIONS mm(inch)		PACKAGE
SYMBOL		SMF
ITEM		
Carrier width	A	2.93(0.115)Max
Carrier length	B	4.85(0.191)Max
Sprocket hole	d	ø1.55(0.061)Typ
Reel outer diameter	D	330.0(13.0)Typ
Reel inner diameter	D1	50.0(1.969)Min
Feed hole diameter	D2	13.0(0.512)Typ
Sprocket hole position	J	1.75(0.069)Typ
Punch hole position	H	5.50(0.217)Typ
Carrier depth	K	1.42(0.056)Typ
Punch hole pitch	P	8.00(0.314)Typ
Sprocket hole pitch	P0	4.00(0.157)Typ
Embossment center	P1	2.00(0.079)Typ
Overall tape thickness	T	0.25(0.010)Typ
Tape width	W	12.0(0.472)Typ
Reel width	W1	12.4(0.488)Min